



**1. Self-drive Operation from the Basket**  
The operating panel is automatically in the basket when the boom is down in transport position, thus enabling the operation of the outriggers and the self-drive from the basket. It is not necessary for the lift user to leave the basket in order to change or move working positions.



**2. The diesel engine can be mounted either with or without a generator. The diesel engine is started and stopped from the basket.**

## The Big DL-SERIES from DENKA LIFT - Towable Trailer Mounted Boom Lift

The DL-series is specially constructed for users that desire reliability, safety, and easy service, as well as high working height and outreach, with a lightweight, towable trailer design.

These lifts are towable using a standard ball hitch, a convenient and simple method to transport the lift from location to location, either within a project campus or long distances.

Thanks to the built-in maneuver function (self-drive), which is operable from the basket, the lift can easily be moved over short distances by one person and without the need for loading on a trailer.

Working heights from 82 (DL25 model) to 98 feet (DL30 model).

Automatic safety sensors allow for optimum outreach of the machine to suit the load in the basket.

The standard model comes equipped with eight 6V batteries. This large battery capacity prolongs the operating time and makes the lift especially suitable for job tasks with changing working positions.

An optional diesel generator for outdoor use can provide lift operation totally independent from the use of batteries.

All DENKA LIFTS meet OSHA and ANSI safety standards.

The electrical and hydraulic systems have double safety devices and the cylinders have hose break valves.

## Technical data

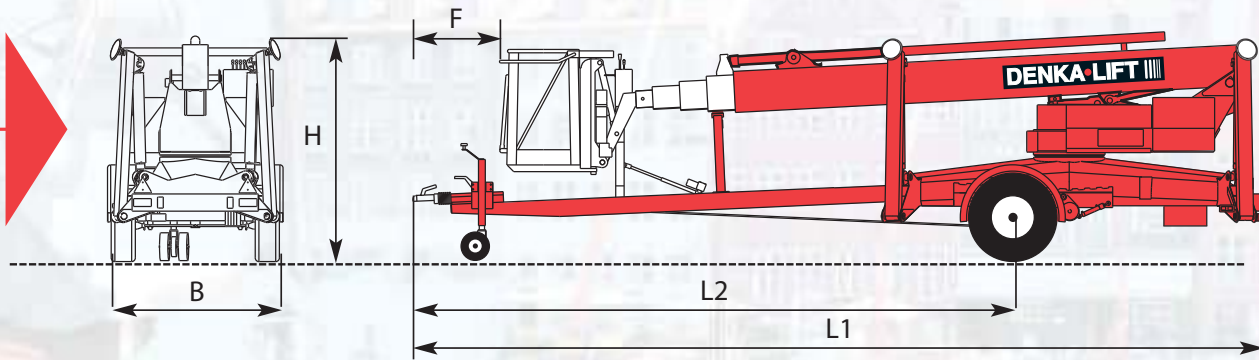

## Max working height

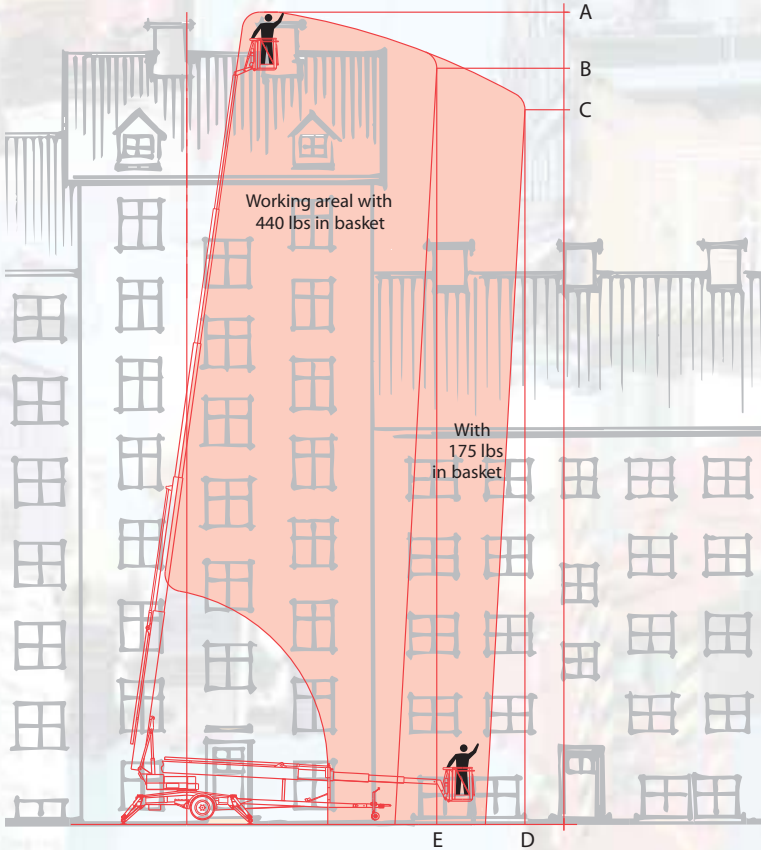

## Outrigger cross section

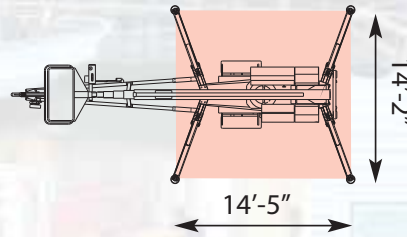

	Standard model DL25	DL30
<b>Capacity</b>		
Max. working height A	82'	98'
Working height B	75'-5"	93'
Working height C	70'-2"	89'-6"
Max. reach D	39'-4"	38'
Reach E	29'-6"	28'-2"
Max. load in basket	440 lbs	440 lbs
Slew movement	cont. 360	cont. 360
<b>Transport dimensions</b>		
Length L1	26'-6"	29'-3"
Length L2	18'-6"	20'-11"
Height H <sup>†</sup>	7'	7'
Width B	5'-8"	5'-8"
Distance F	2'-10"	3'
Net weight standard	7,055 lbs	7,700 lbs

### STANDARD EQUIPMENT:

- 3'-11" Rotating Aluminum Basket
- Battery operation
- Proportional controls
- Hydraulic outriggers
- ELCB 30 mA
- Hour meter
- Charging key
- Hydraulic wheel drive from basket

This data is a guideline only. Pictures may show special equipment that is not part of the standard equipment we reserve the right to make alterations.

### OPTIONAL ACCESSORIES:

- 3'-11" Rotating fiberglass basket\* (only DL25)
  - Outlets for Water/air in the basket\*
  - Yellow rotating light
  - Height limiting system 2 steps
  - Diesel engine 5.2 KW with charging generator 230V / 2.2 Kw (SP)\*
  - Special colors
  - Yellow flashing light on outriggers
  - High capacity battery\*
  - †Height adjusting wheel axle (Reduces transport height to 6'-3")\*
  - Biological degradable hydraulic oil
  - Adjustable Basket from ground level
- \* increase in weight

Nationwide Rentals, Sales, and Service



**SERVICE ONE ACCESS, INC.**

2850 West Fulton Street, Chicago, IL 60612

**800.298.7990**

**www.denkalift.com**

